Content

1 General Information	2
2 Safety Measures	3
3 Technical Parameters	5
4 Product Overview	6
4.1 Brief Introduction	6
4.2 Hardware and Instructions	7
4.2.1 Power Switch	7
4.2.2 Dip Switch Definition	7
4.2.3 RS485-1/CAN Inverter Communication Port	8
4.2.4 RS232 Upper Computer Port	8
4.2.5 RS485-2 Battery Parallel Port	9
4.3 LED Display Description	9
4.3.1 Enter Setting Page	9
4.3.2 Check Voltage Information of Each Cell	10
4.3.3 Communication Protocol Setting	10
4.3.4 Alarm Warning Information	11
5 Installation guide	12
5.1 Inspection Before Installation	12
5.1.1 Check the Outer Packaging	12
5.1.2 Check Whether the Accessories Are Complete	12
Accessories list in the package	12
5.2 Tools	15
5.3 Installation Requirements	15
5.4 Installation Instructions	15
5.4.1 Overall Dimensions	15
5.4.2 Fix the Battery	16
5.4.3 Connect the Power Cable	17
5.4.4 Connect the Internal Communication Line	17
5.4.5 Set BMS Communication Address	17
5.4.6 Connect the Built-in Wifi Module (Optional)	18
6 Cleaning and Maintenance	20
6.1 Cleaning Work	20
6.2 Maintenance	20
6.2.1 Recharging Requirements During Normal Storage	20
6.2.2 Recharging Requirements for Excessive Discharge	20
7 Common Issues and Solutions	20
7.1 Common Issues and Solutions	20
7.2 Emergency	22
7.3 About Battery System	22

51.2V200/280/314Ah-LV

1 General Information

This manual introduces the **51.2V200/280/314Ah-LV** battery products. Which includes: battery information, using way, guide, safety information, installation guide, common issues and maintenance. Please read this manual carefully before using the battery. For any questions, please contact the authorized dealer immediately for advice and clarification.









51.2V200/280/314Ah-LV is an energy storage unit, that is designed for residential application scenarios with the capability of short-term backup, not suitable for supporting life-sustaining medical devices. This product is intended for used only in accordance with the information provided in the enclosed documents and applicable local standards and regulations. Any other use may result in personal injury or property damage. The illustrations in this manual are only intended to help explain the concept of the system configuration, including use guidelines, safety precautions, common operating problems, and subsequent battery maintenance.

Alterations to the product, e.g. changes or modifications, are only permitted with the express written permission of the authorized dealer. Unauthorized changes will not be allowed by warranty claims. the authorized dealer shall not be liable for any damage resulting from such changes. Any use of the product other than described in the intended use section does not qualify as appropriate. The enclosed documentation is an integral part of this product. Please keep the documentation in a safe and convenient place for future reference.

The type labels were attached on the product, which contain the product identification information. For safe usage, the user must be well-informed of the contents in the type labels.

51.2V200/280/314Ah-LV

Labels:

Lithium-ion Battery Pack		Lithium-ion Battery Pack		Lithium-ion Battery Pack	
Battery Model	51.2V200Ah	Battery Model	51.2V280Ah	Battery Model	51.2V314Ah
Description	51.2V200Ah-LV	Description	51.2V280Ah-LV	Description	51.2V314Ah-LV
Total Energy Capacity(Wh)	10240	Total Energy Capacity(Wh)	14336	Total Energy Capacity(Wh)	16077
Rated Voltage (V dc)	51.2	Rated Voltage (V dc)	51.2	Rated Voltage (V dc)	51.2
Rated Capacity (Ah)	200	Rated Capacity (Ah)	280	Rated Capacity (Ah)	314
Max.Output Power(W)	6144	Max.Output Power(W)	10240	Max.Output Power(W)	10240
Maximum Current (A)	120	Maximum Current (A)	200	Maximum Current (A)	200
Reference Weight (Kg)	77	Reference Weight (kg)	102	Reference Weight (kg)	105
<p>CAUTION! Do not disassemble Do not short-circuit Donot place in fire or near hot source Please read user manual carefully</p>		<p>CAUTION! Do not disassemble Do not short-circuit Donot place in fire or near hot source Please read user manual carefully</p>		<p>CAUTION! Do not disassemble Do not short-circuit Donot place in fire or near hot source Please read user manual carefully</p>	
UN38.3, MSDS, CE, ROHS,IEC62619		CE, UN38.3, MSDS		CE, UN38.3, MSDS	
  		  		  	

2 Safety Measures

This section contains safety information that must always be observed when using or installing batteries. To prevent personal injury or property damage and ensure long-term operation of the batteries, please read this section carefully, always watch for warnings from all safety messages.

Environmental requirements:

1. Do not expose the battery to temperature above 50 °C;
2. Do not place the battery near any heat source;
3. Do not expose the battery to moisture or liquid;
4. Do not expose the battery to a corrosive gas or liquid;
5. Do not expose the battery to a combustible gas or liquid;
6. Place the battery in safe place that away from children and animals.

51.2V200/280/314Ah-LV

Operation Precautions:

1. Do not disassemble the battery;
2. Do not touch the battery pack with wet hands;
3. Do not smash, fall, or puncture the battery;
4. Do not short-circuit the terminal, and remove all metal jewelry items that may produce a short-circuit before installation and repair;
5. Always handle the products in accordance with the local safety regulations;
6. Store and use the battery in the user's manual, 8.Ensure reliable grounding;
7. Disconnecting all batteries to the wires before installation and repair;
8. The stacking of packaging batteries shall not exceed the quantity specified on the packaging.

51.2V200/280/314Ah-LV

3 Technical Parameters

Model	51.2V200Ah-LV	51.2V280Ah-LV	51.2V314Ah-LV
Electrical parameters			
Nominal capacity	200Ah	280Ah	314Ah
Nominal voltage	51.2V	51.2V	51.2V
Total energy	10240W.h	14336W.h	16077W.h
Depth of discharge (90%DOD)	9216W.h	12902W.h	14469W.h
Charging voltage	57.6V	57.6V	57.6V
End voltage	46.4V	46.4V	46.4V
Maximum current	120A	200A	200A
Maximum power	6144W	10240W	10240W
General parameters			
Battery type	LiFePO4		
Working humidity	≤85%rh		
Store humidity	≤85%rh		
Working altitude	≤2000m		
Maximum number of parallel	15pcs		
Protection level	IP20		
Net weight	77Kg	102.2kg	105.4kg
Dimension	605*383*240(mm)	745*387*240(mm)	745*387*240(mm)
Certificate	CE, ROHS, IEC62619, MSDS, UN38.3	CE, MSDS, UN38.3	CE, MSDS, UN38.3
Cycle life	≥ 6000 times	≥ 10000 times	≥ 11000 times
Communication port	CAN,RS485, RS232		
Discharging working temperature	-20°C ~ 60°C		
Charging working temperature	0°C ~ 60°C		
Storage temperature	12 months, ≤25°C		
	6 months, ≤35°C		
	3 months, ≤45°C		
Warranty	5 years		

51.2V200/280/314Ah-LV

4 Product Overview

4.1 Brief Introduction

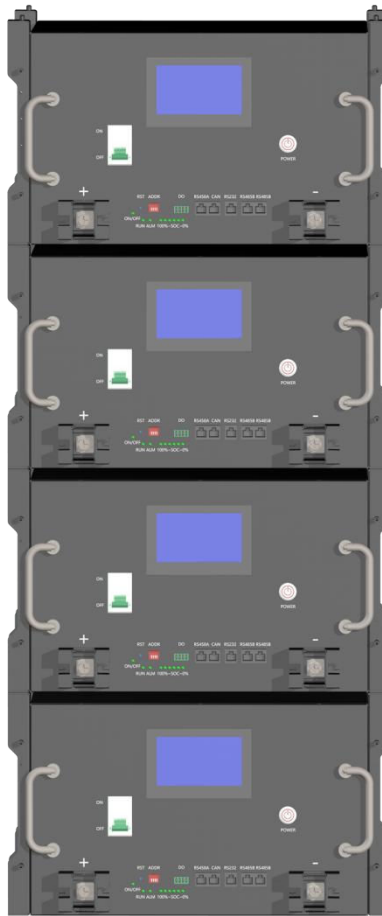

51.2V200/280/314Ah-LV is a lithium battery energy storage system with an operating voltage range of between 46.4~57.6v, it is used for household energy storage applications, in cooperation with low voltage inverters to achieve home energy storage purpose.

51.2V200/280/314Ah-LV has a built-in BMS (Battery Management System) which can manage and monitor cells information, including voltage, current and the temperature. In addition, the BMS can balances battery charging to extend lifespan. BMS has the protections including over-discharge, overcharge, over-current, high / low temperature, etc. The exterior is equipped with a touch color screen, status indicator and power indicator, which can clearly observe the status of the energy storage system or switch to the communication protocol with other brands.

The system can automatically manage the charging status, discharge state, balance state. Multiple batteries can be connected in parallel to expand storage capacity to meet larger capacity and continuous power support time, **51.2V200/280/314Ah-LV** support up to 15 parallel operations.

51.2V200/280/314Ah-LV

4.2 Hardware and Instructions

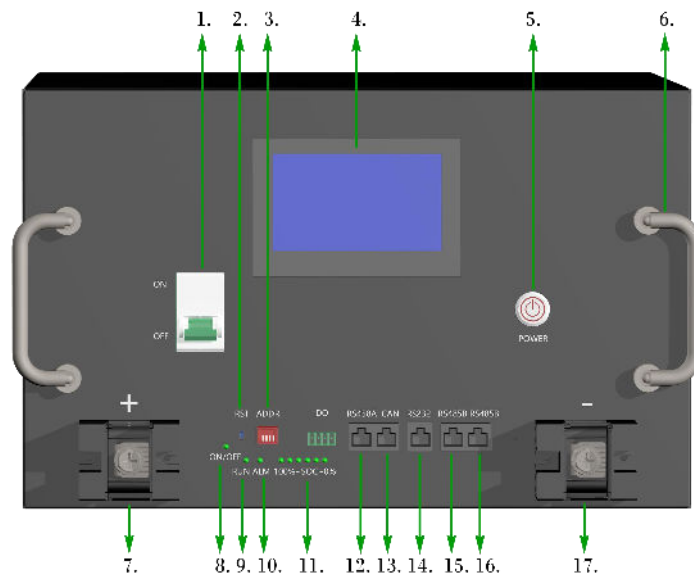

NO.	Items	NO.	Items
1.	Protective cut-off switch	2.	BMS force reset switch
3.	ADDR dial address	4.	LED display
5.	Power Switch	6.	U-type pull
7.	Battery positive pole	8.	Power light
9.	Normal operating light	10.	Alarm light
11.	Power indicator light	12.	RS485A port-inverter communication
13.	CAN port-inverter communication	14.	RS232 port-upper computer communication
15.	RS485B port-battery parallel communication	16.	RS485B port-battery parallel communication
17.	Battery negative pole		

4.2.1 Power Switch

Press the power switch, release the button, and the button is locked.

4.2.2 Dip Switch Definition

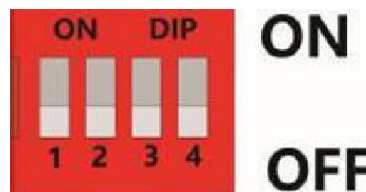

Schematic Diagram of the Dial-up Switch

51.2V200/280/314Ah-LV

The dial-dip switch is used to set the BMS address of each battery. The code value of the dial-ON position is 1, and the code value of the dial-1234 position is 0.

The host battery address is 1, and the slave battery address is 2 to 15. (The host is connected to the inverter, and the slave machines are arranged in numerical order according to the address)

The dial-up address table is as follows:

Dial-up code location				Add	Dial-up code location				Add	Dial-up code location				Add	Dial-up code location				Add
#1	#2	#3	#4		#1	#2	#3	#4		#1	#2	#3	#4		#1	#2	#3	#4	
0	0	0	0	X	0	0	1	0	4	0	0	0	1	8	0	0	1	1	12
1	0	0	0	1	1	0	1	0	5	1	0	0	1	9	1	0	1	1	13
0	1	0	0	2	0	1	1	0	6	0	1	0	1	10	0	1	1	1	14
1	1	0	0	3	1	1	1	0	7	1	1	0	1	11	1	1	1	1	15

4.2.3 RS485-1/CAN Inverter Communication Port



RS485-1				CAN			
	Definition description		Definition description		Definition description		Definition description
PIN1	RS485-B	PIN5	/	PIN1	/	PIN5	CAN-L
PIN2	RS485-A	PIN6	/	PIN2	/	PIN6	/
PIN3	/	PIN7	RS485-A	PIN3	/	PIN7	/
PIN4	/	PIN8	RS485-B	PIN4	CAN-H	PIN8	/

The CAN communication terminal (RJ45 port) follows the CAN/RS485 protocol and connects to the inverter BMS for communication. The BMS controls the charging current/charging voltage or discharge current/discharge cut-off voltage of the inverter based on the battery voltage and battery temperature through CAN/RS485 communication.

4.2.4 RS232 Upper Computer Port

51.2V200/280/314Ah-LV

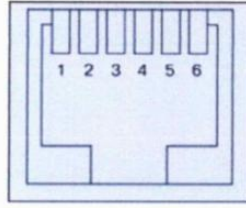

	Definition description		Definition description
PIN1	/	PIN4	RX
PIN2	/	PIN5	GND
PIN3	TX	PIN6	/

RS232 communication port (RJ11 port) follows RS232 protocol, support the connection with upper computer to read and modify the battery spec.

4.2.5 RS485-2 Battery Parallel Port

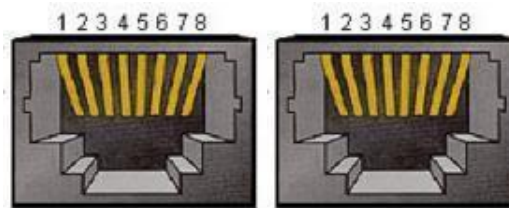

	Definition description		Definition description
PIN1	RS485-B	PIN5	/
PIN2	RS485-A	PIN6	/
PIN3	/	PIN7	RS485-A
PIN4	/	PIN8	RS485-B

4.3 LED Display Description

4.3.1 Enter Setting Page



Main setting page display the real time battery SOC, total voltage and current.

4.3.2 Check Voltage Information of Each Cell



Click the right arrow icon to check the voltage of each cell.

- 1) Respectively in the figure shows the single section of 16 series of batteries batteries voltage.
- 2) In green (3.308mv) shows the minimum voltage of cell, and is cell 5.
- 3) Figure in red (3.313mv) shows the highest voltage of cell, and is cell 1.
- 4) Voltage shows the values for the total voltage, Current shows the real time current.

4.3.3 Communication Protocol Setting

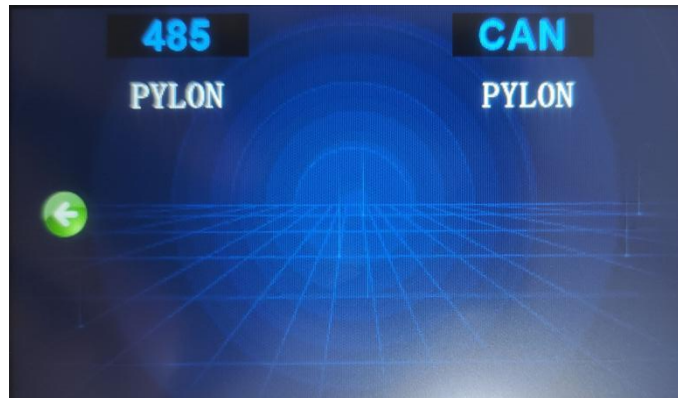

Click the right arrow icon to enter the setting page.

- 1) Click RS485 to enter the setting page, select the communication protocol, click SAVE to SAVE, click CANCEL to CANCEL the choice.
- 2) Click CAN to enter the setting page, select the communication protocol, click SAVE to SAVE, click CANCEL to CANCEL

51.2V200/280/314Ah-LV

4.3.4 Alarm Warning Information



When an alarm is generated, an alarm icon is displayed on the home page. Click the icon to view alarm details.

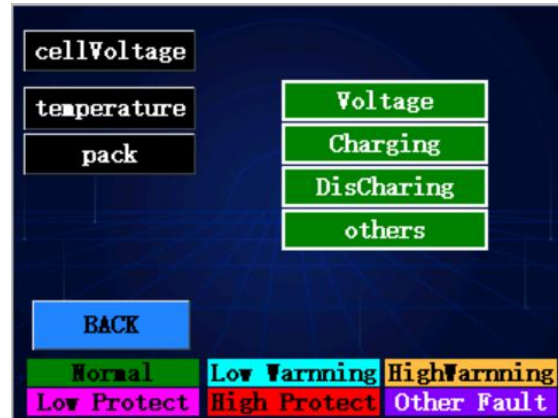
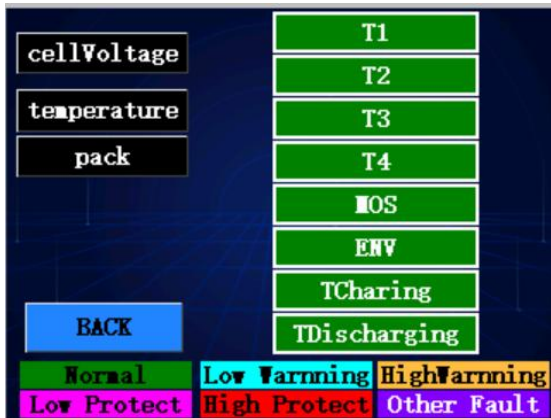
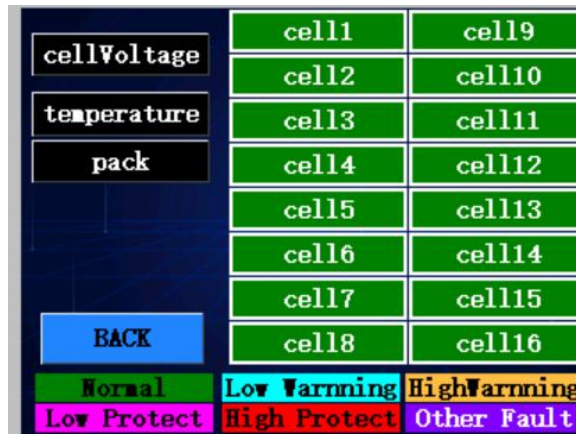

Name	Define
Cell voltage	Cell voltage
Temperature	Cell temperature
Pack	Battery pack status
Normal	Normal
Low warning	Low voltage warning
High warning	Over voltage warning

51.2V200/280/314Ah-LV

Low protect	Low voltage protection
High protect	Over voltage protection
Other fault	Others

5 Installation guide

5.1 Inspection Before Installation

5.1.1 Check the Outer Packaging

Packaging materials and components may be damaged during transportation. Therefore, please check the packaging material before installing the battery. Check the surface of packaging materials for damage, such as holes and cracks. If any damage is found, do not unpack the battery and contact the dealer as soon as possible. It is recommended that you remove the packaging material within 24 hours before installing the battery.

5.1.2 Check Whether the Accessories Are Complete

After opening the packing box, check whether the attached accessories are complete. If any damage or missing parts are found, contact your dealer.

Accessories list in the package

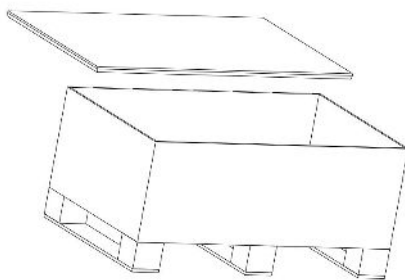

51.2V200/280/314Ah-LV

51.2V200/280/314Ah-LV					
NO.	Name	Model	Unit	Qty	Mark
1.	Battery	51.2V200Ah-LV	PCS	1	Based on order model
1.	Battery	51.2V280Ah-LV			
1.	Battery	51.2V314Ah-LV			
2.	Side ear sheet metal	Steel	SET	2	
3.	Side ear sheet metal fixing screw	M4	PCS	8	
4.	RS232-USB cable		SET	1	For upper computer connection
5.	Aviation plug	120A, orange +, black -	SET	1	
6.	Extra soft silicone wire	4AWG, black, 1.5M	PCS	1	For inverter connection
		4AWG, red, 1.5M	PCS	1	
7.	OT terminal	25-10	PCS	2	Back-up
8.	Heat shrinkable tube	Ø12 (40mm)	PCS	2	Back-up
9.	Communication cable	1+1 crystal head/ 1.5m	PCS	1	For inverter communication
		Network cable 1m	PCS	1	Back-up
		1+1 crystal head/ 0.2m	PCS	1	For battery parallel
10.	Crystal head	8P/ gilding 3U	PCS	2	Back-up
11.	Assemble stacked sheet	Steel	PCS	4	Optional
12.	Isolation column	M4*32	PCS	4	Optional
13.	Acrylic sheet		PCS	1	Optional
14.	Built-in WIFI module		PCS	1	
15.	User manual	51.2V200/280/314Ah-LV manual	PCS	1	

51.2V200/280/314Ah-LV

Manufacturing instructions for power cable terminals:

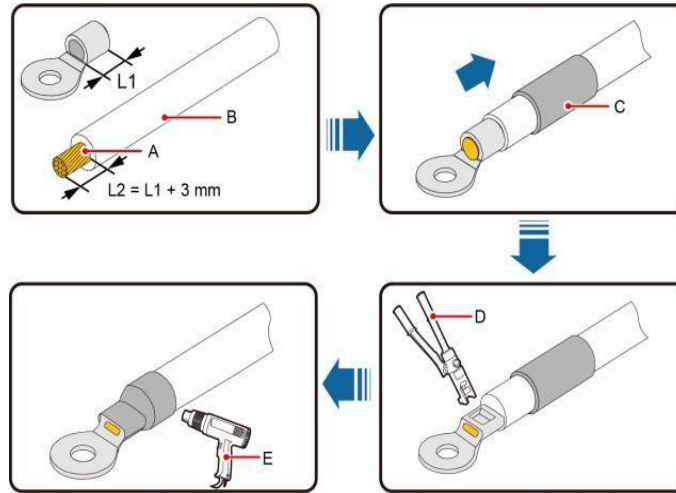



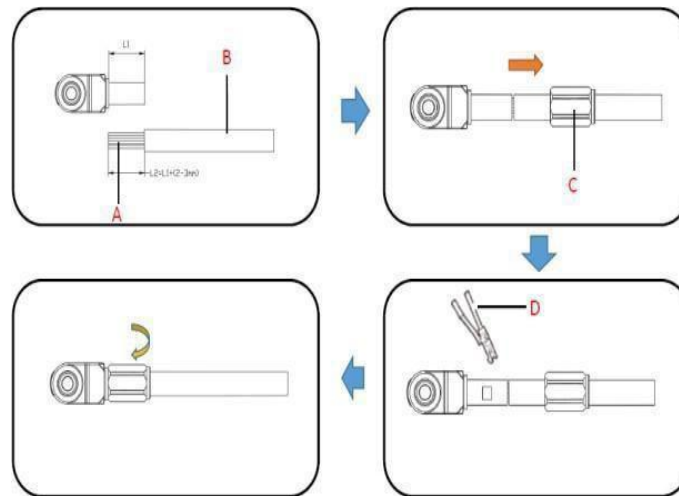





- (A)Copper Core Line (B) Insulation layer
- (B)Heat-shrink tube (D) Hydraulic pliers
- (E)Hot-air gun

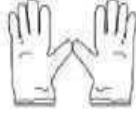

- (A) Copper Core Line (B) Insulation layer
- (C) Protective cover (D) Hydraulic pliers

5.2 Tools

Type	Tools			
Installation tools	Measuring tape 	Hammer drill 	Socket wrench 	Cross screwdriver 
Protective equipments	ESD gloves 	Safety goggles 	Anti-dust respirator 	Safety shoes 

5.3 Installation Requirements

1. Install the battery in an indoor environment.
2. Place the battery in a safe position away from children and animals.
3. Do not place the battery near any heat source, and avoid generating sparks.
4. Do not expose the battery to moist air or liquid.
5. Do not expose the battery to direct sunlight.
6. Do not expose the battery to a combustible gas or liquid.
7. The mounting carrier shall be fire resistant. Do not install batteries on flammable buildings.

5.4 Installation Instructions

5.4.1 Overall Dimensions



51.2V200Ah-LV

51.2V200/280/314Ah-LV



51.2V280/314Ah-LV

5.4.2 Fix the Battery

To ensure ventilation, dry heat dissipation, keep 300mm open around the battery. The spacing between battery stacks should be at least 20mm.

1. Multiple batteries parallel - assembly stack sheet metal installation:

Install stacked sheet metal at the four corners of each battery, install the supporting feet on the bottom battery, and stack battery modules one by one.

2. Multiple batteries parallel - battery cabinet installation:

Battery cabinet could be ordered from the authorized dealer or ask for dimension for self-made.

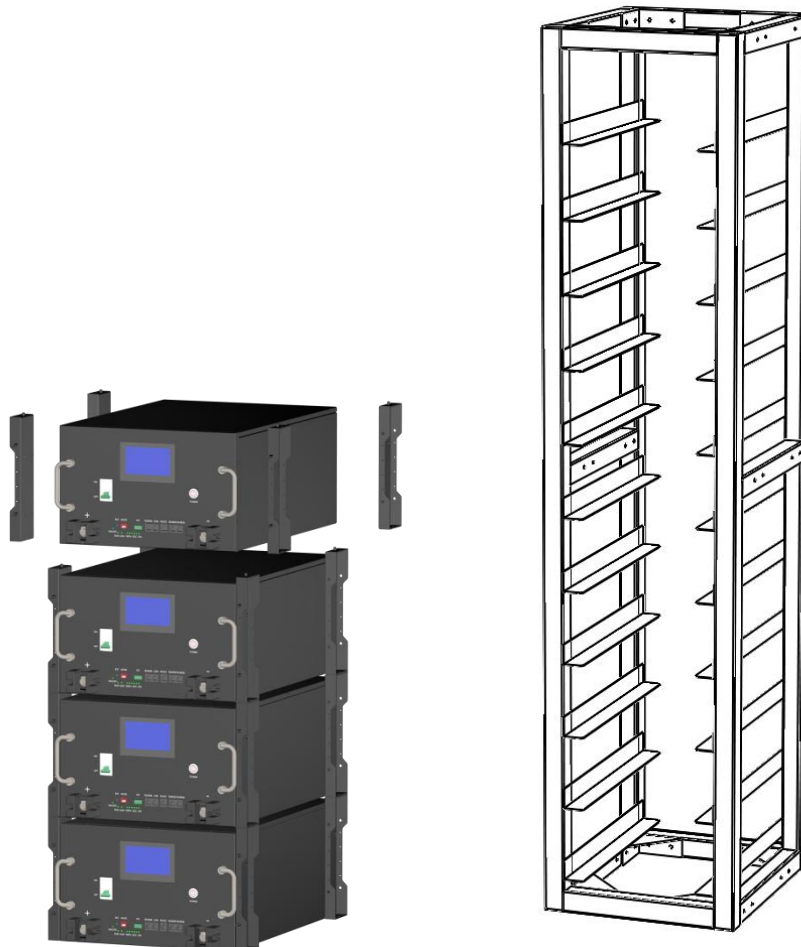

51.2V200/280/314Ah-LV

5.4.3 Connect the Power Cable

If need parallel, ensure that the voltage difference between parallel batteries is within 1V; for system efficiency, it is recommended the the battery production date within 1 year.

Put the positive battery terminals together, and the negative battery terminals together.

To ensure capacity balance between batteries, staggered positive and negative battery terminals must be connected to the inverter. For example, the upper left positive port and the lower right negative port are respectively connected to the positive and negative terminals of the inverter; Or the lower left positive port and the upper right negative port are connected to the positive and negative electrodes of the inverter respectively.

5.4.4 Connect the Internal Communication Line



According to inverter communication, the host battery (ADDR value set 1000) choose CAN/RS485 port connects to the inverter; set battery inner communication with RS485-2.

5.4.5 Set BMS Communication Address

51.2V200/280/314Ah-LV

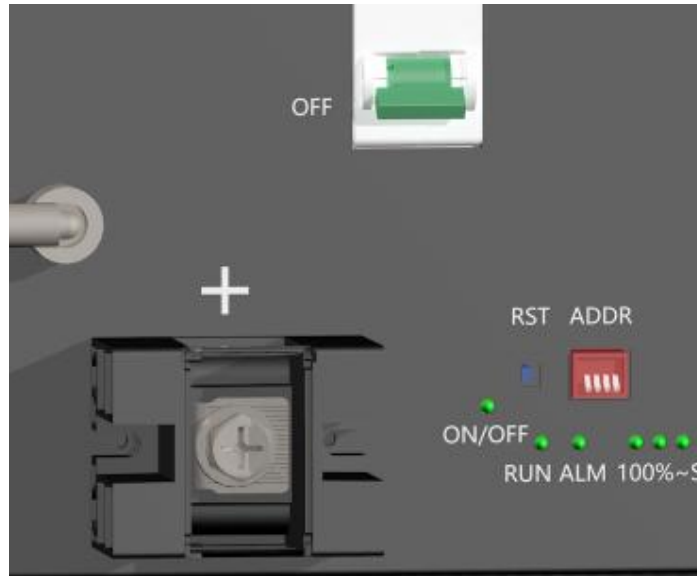

Please refer to 4.2.2: the dialing rule is to set the battery module address in sequence.

5.4.6 Connect the Built-in Wifi Module (Optional)

After downloading the monitoring software, you can choose between Bluetooth connection and wifi binding. After binding to wifi, you can remotely monitor, modify parameters, and upgrade programs.

If there is an optional wifi module, please refer to the attached wifi manual for specific connection settings.

51.2V200/280/314Ah-LV

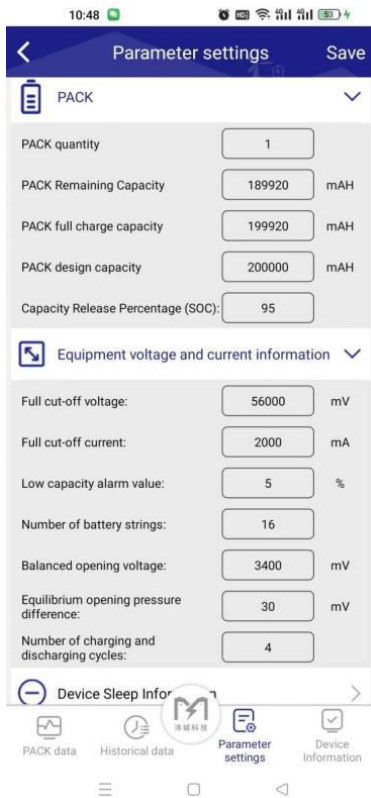
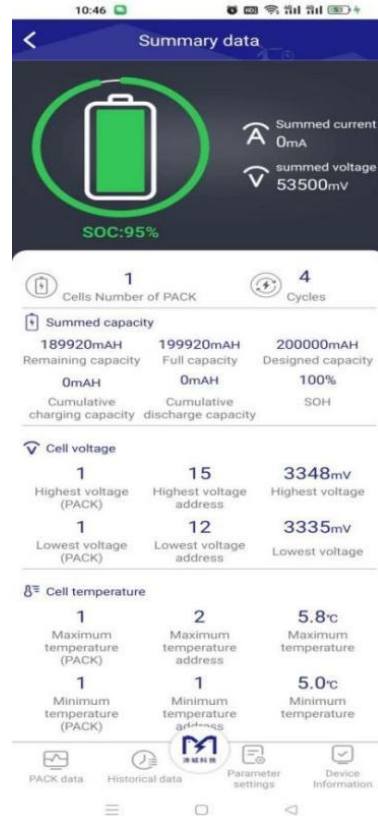

51.2V200/280/314Ah-LV

6 Cleaning and Maintenance

6.1 Cleaning Work

Please note: please turn off the power supply of the system before cleaning. It is recommended to clean battery regularly. If the shell is dirty, please use a soft and dry brush or dust collector to remove the dust. Do not use solvents, or corrosive liquids to clean the enclosure.

6.2 Maintenance

6.2.1 Recharging Requirements During Normal Storage

The battery shall be stored in an environment with a temperature range of $-10^{\circ}\text{C}\sim 45^{\circ}\text{C}$ and shall be maintained regularly according to the following table to 0.5C current is charged until 60%SOC after long storage.

Charging conditions during storage

Store the ambient temperature	Relative humidity of the storage environment	Storage time	SOC
Below -10°C		Prohibit	/
$-10\sim 25^{\circ}\text{C}$	5%~70%	≤ 12 months	$30\%\leq \text{soc}\leq 60$
$25\sim 35^{\circ}\text{C}$	5%~70%	≤ 6 months	$30\%\leq \text{soc}\leq 60$
$35\sim 45^{\circ}\text{C}$	5%~70%	≤ 3 months	$30\%\leq \text{soc}\leq 60$
Above 45°C		Prohibit	

6.2.2 Recharging Requirements for Excessive Discharge

Charge the over-discharge (90%DOD) battery within the time of meeting the table below, otherwise the over-discharge battery module will be damaged.

Charging requirements for excessive battery discharge

Storage environment temperature	Storage time	Note:
$-10\sim 25^{\circ}\text{C}$	\leq on Day 15	The battery pack disconnected to PCS, charge the battery with DC charger.
$25\sim 45^{\circ}\text{C}$	\leq on Day 7	
$-10\sim 45^{\circ}\text{C}$	<12 hours	Battery pack connect to the

7 Common Issues and Solutions

7.1 Common Issues and Solutions

The user can monitor the operating status, warning, and alarm information through the inverter LCD display.

51.2V200/280/314Ah-LV

1. The battery cannot be turned on, and the LED indicator lights all turn off the battery depth discharge and requires charging first. If the external charger supply voltage is 51V or above and the battery still cannot be opened, contact the authorized dealer.

2. If red light shows system abnormal, please check below values:

1) Temperature: Above 60°C or below 0°C, the battery protection turns on, could not charge.

Solution: Move the battery to normal operating temperature range between 0°C to 60 °C.

2) Temperature: above 60°C or below -20°C, the battery cannot discharge.

Solution: Move the battery to normal operating temperature range between -20°C to 60 °C.

3) Current: If current is greater than 120A(51.2V200Ah)/ 200A(51.2V280/ 314Ah), the battery protection device will be turned on.

Solution: Stop using electrical appliances that exceed the maximum battery power load.

4) High voltage: If the battery voltage is above 57.9V or above, battery charging protection turns on.

Solution: The inverter will stop charging the battery if it sets the intelligent LI mode or a reasonable charging voltage.

5) Low voltage: The battery discharge protection is turned on when the battery discharges to 46.4V or lower.

Solution: Charge the battery until the red light goes off.

Excluding the above five points, if the fault cannot be found, turn off the battery and contact the authorized dealer.

3. It's normal that the SOC LED are different if in multiple battery parallel systems. Before installing batteries in parallel, measure the voltage of each battery to ensure that the voltage difference of each battery is within 1V, and the the battery production date within 1 year.

1) When installing for the first time, please charge in full first to balance the capacity gap;

2) If the error is within 10% when the lowest SOC display percentage is compared with the highest SOC display percentage, and the SOC display percentage is the same within 10 minutes, it is normal operation;

3) Before expanding battery capacity, please charge and discharge the online battery to 45%-50%SOC; After expanding the capacity, charge the battery system to balance the capacity gap. Ensure that the capacity difference before parallel is no more than 10%. If the capacity gap is large, it will take about 2 cycles to balance the capacity gap. The actual equilibrium time depends on the capacity difference and the charge-discharge current.

Exclude the above three points. If the SOC display still fails, please contact the authorized dealer.

7.2 Emergency

Please cut off the power supply and turn off the battery in an emergency.

1. **If the battery pack is damp or immersed in water**, do not get close to the battery, and then contact the authorized dealer or an authorized dealer for technical support.
2. **Do not use water to fire when a fire!** Only dry powder extinguishers; place the battery pack in a safe area if possible.
3. **Battery leaking the electrolyte** **If the battery pack leaks the electrolyte**, avoid contact with leaking liquid or gas.

If someone is exposed to the leaking material, do the following immediately:

Inhalation: evacuate the contaminated areas and seek medical treatment.

Contact eye: Rinse eyes with running water for 15 minutes and seek medical treatment.

Contact skin: Wash the infected site with soap and water and seek medical treatment.

Swallow in: urge vomiting, and seek medical treatment.

Battery damage: Damaged battery is dangerous and must be treated with very carefully. Battery cannot be used or may be dangerous to person or property. If the battery pack is damaged, contact the authorized dealer for handling.

7.3 About Battery System

1. The system treatment must comply with the locally applicable disposal regulations of electronic waste and second-hand batteries.
2. Do not treat the battery system along with household waste.
3. Avoid exposing the battery to high heat or direct sunlight.
4. Avoid exposing the battery to high humidity or corrosive environments.
5. Do not expose the battery to a combustible gas or liquid.