



User Manual

NSTLV-10.2/14.3/16K



Content

1 General Information	2
2 Safety Measures	4
3 Technical Parameters	5
4 Product Overview	6
4.1 Brief Introduction	6
4.2 Hardware and Instructions	6
4.2.1 Start Button	7
4.2.2 Dip Switch Definition	7
4.2.3 COM1 Port	8
4.2.4 COM2 Port	8
4.3 LED Display Description	9
4.3.1 Main Sate Interface	9
4.3.2 Home Interface	9
4.3.3 Menu Structure	10
5 Installation guide	11
5.1 Inspection Before Installation	11
5.1.1 Check the Outer Packaging	11
5.1.2 Check Whether the Accessories Are Complete	11
5.2 Tools	14
5.3 Installation Requirements	14
5.4 Installation Instructions	14
5.4.1 Overall Dimensions	14
5.4.2 Minimum Installation Distance	16
5.4.3 Fix the Battery	16
5.4.4 Connect the Power Cable	17
5.4.5 Connect the Internal Communication Line	18
5.4.6 Set BMS Communication Address	18
5.4.7 Connect the Built-in Wifi Module (Optional)	19
6 Cleaning and Maintenance	20
6.1 Cleaning Work	20
6.2 Maintenance	20
6.2.1 Recharging Requirements During Normal Storage	20
6.2.2 Recharging Requirements for Excessive Discharge	20
7 Common Issues and Solutions	21
7.1 Common Issues and Solutions	21
7.2 Emergency	22
7.3 About Battery System	22

NSTLV-10.2/14.3/16K

1 General Information

This manual introduces the NSTLV-10.2/14.3/16K battery products. Which includes: battery information, using way, guide, safety information, installation guide, common issues and maintenance. Please read this manual carefully before using the battery. For any questions, please contact the authorized dealer immediately for advice and clarification.

NSTLV-10.2/14.3/16K is an energy storage unit, that is designed for residential application scenarios with the capability of short-term backup, not suitable for supporting life-sustaining medical devices. This product is intended for use only in accordance with the information provided in the enclosed documents and applicable local standards and regulations. Any other use may result in personal injury or property damage. The illustrations in this manual are only intended to help explain the concept of the system configuration, including use guidelines, safety precautions, common operating problems, and subsequent battery maintenance.

Alterations to the product, e.g. changes or modifications, are only permitted with the express written permission of the authorized dealer. Unauthorized changes will not be allowed by warranty claims. The authorized dealer shall not be liable for any damage resulting from such changes. Any use of the product other than described in the intended use section does not qualify as appropriate. The enclosed documentation is an integral part of this product. Please keep the documentation in a safe and convenient place for future reference.

The type labels were attached on the product, which contain the product identification information. For safe usage, the user must be well-informed of the contents in the type labels.



NSTLV-10.2/14.3/16K

Labels:

Lithium-ion Battery Pack	
Battery Model	NSTLV-10.2K
Total Energy Capacity(Wh)	10240
Rated Voltage (V dc)	51.2
Rated Capacity (Ah)	200
Max.Output Power(W)	6144
Maximum Current (A)	120
Reference Size(mm)	519*204*712
Reference Weight (Kg)	95

CAUTION!
Do not disassemble
Do not short-circuit
Donot place in fire or near hot source
Please read user manual carefully



UN38.3, MSDS, CE, ROHS, IEC62619

Lithium-ion Battery Pack	
Battery Model	NSTLV-14.3K
Total Energy Capacity(Wh)	14336
Rated Voltage (V dc)	51.2
Rated Capacity (Ah)	280
Max.Output Power(W)	10240
Maximum Current (A)	200
Reference Size(mm)	519*204*854
Reference Weight (Kg)	125

CAUTION!
Do not disassemble
Do not short-circuit
Donot place in fire or near hot source
Please read user manual carefully



UN38.3, MSDS, CE, ROHS

Lithium-ion Battery Pack	
Battery Model	NSTLV-16K
Total Energy Capacity(Wh)	16077
Rated Voltage (V dc)	51.2
Rated Capacity (Ah)	314
Max.Output Power(W)	10240
Maximum Current (A)	200
Reference Size(mm)	519*204*854
Reference Weight (Kg)	127

CAUTION!
Do not disassemble
Do not short-circuit
Donot place in fire or near hot source
Please read user manual carefully

UN38.3, MSDS, CE, ROHS, IEC62619



DANGER !
CHEMICAL HAZARD &
SHOCK HAZARD

- Do not disassemble or repair by yourself.
- Do not drop, deform, impact, cut or spear with a sharp object.
- Do not place near open flame or incinerate.
- Do not put any objects onto the battery.
- Do not allow to contact with liquid.
- Keep out of reach of children, animals or insects.
- Contact the supplier within 24 hours if anything wrong.

WARNING !









Stop the battery operation immediately to secure the battery safety when environmental temperature is over working temperature (suitable operation temperature is 0-45°C).
If battery is at high temperature usually, it will impact battery performance.

2 Safety Measures

This section contains safety information that must always be observed when using or installing batteries. To prevent personal injury or property damage and ensure long-term operation of the batteries, please read this section carefully, always watch for warnings from all safety messages.

Environmental requirements:

1. Do not expose the battery to temperature above 50 °C;
2. Do not place the battery near any heat source;
3. Do not expose the battery to moisture or liquid;
4. Do not expose the battery to a corrosive gas or liquid;
5. Do not expose the battery to a combustible gas or liquid;
6. Place the battery in safe place that away from children and animals.

Operation Precautions:

1. Do not disassemble the battery;
2. Do not touch the battery pack with wet hands;
3. Do not smash, fall, or puncture the battery;
4. Do not short-circuit the terminal, and remove all metal jewelry items that may produce a short-circuit before installation and repair;
5. Always handle the products in accordance with the local safety regulations;
6. Store and use the battery in the user's manual, 8.Ensure reliable grounding;
7. Disconnecting all batteries to the wires before installation and repair;
8. The stacking of packaging batteries shall not exceed the quantity specified on the packaging.

NSTLV-10.2/14.3/16K

3 Technical Parameters

Model	NSTLV-10.2K	NSTLV-14.3K	NSTLV-16K
Electrical parameters			
Nominal capacity	200Ah	280Ah	314Ah
Nominal voltage	51.2V	51.2V	51.2V
Total energy	10240W.h	14336W.h	16077W.h
Depth of discharge (90%DOD)	9216W.h	12902W.h	14469W.h
Charging voltage	57.6V	57.6V	57.6V
End voltage	46.4V	46.4V	46.4V
Maximum current	120A	200A	200A
Maximum power	6144W	10240W	10240W
General parameters			
Battery type	LiFePO4	LiFePO4	LiFePO4
Working humidity	≤85%rh	≤85%rh	≤85%rh
Store humidity	≤85%rh	≤85%rh	≤85%rh
Working altitude	≤2000m	≤2000m	≤2000m
Maximum number of parallel	15pcs	15pcs	15pcs
Protection level	IP54	IP54	IP54
Net weight	95.0Kg	125.3Kg	127.3Kg
Dimension	519*204*712 (mm)	519*204*854 (mm)	519*204*854 (mm)
Certificate	UN38.3, CE, ROHS, IEC62619	UN38.3, CE, ROHS	UN38.3, CE, ROHS, IEC62619
Circle life	≥6000 times	≥10000 times	≥11000 times
Communication port	CAN,RS485, RS232		
Discharging working temperature	-20°C ~ 60°C		
Charging working temperature	0°C ~ 60°C		
Storage temperature	12 months, ≤25°C		
	6 months, ≤35°C		
	3 months, ≤45°C		
Warranty	5 years		

NSTLV-10.2/14.3/16K

4 Product Overview

4.1 Brief Introduction

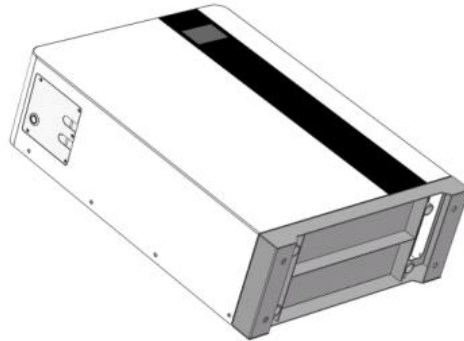

NSTLV-10.2/14.3/16K is a lithium battery energy storage system with an operating voltage range of between 46.4~57.9v, it is used for household energy storage applications, in cooperation with low voltage inverters to achieve home energy storage purpose.

NSTLV-10.2/14.3/16K has a built-in BMS (Battery Management System) which can manage and monitor cells information, including voltage, current and the temperature. In addition, the BMS can balances battery charging to extend lifespan. BMS has the protections including over-discharge, overcharge, over-current, high / low temperature, etc.

The system can automatically manage the charging status, discharge state, balance state. Multiple batteries can be connected in parallel to expand storage capacity to meet larger capacity and continuous power support time, **NSTLV-10.2/14.3/16K** support up to 15 parallel operations.

4.2 Hardware and Instructions

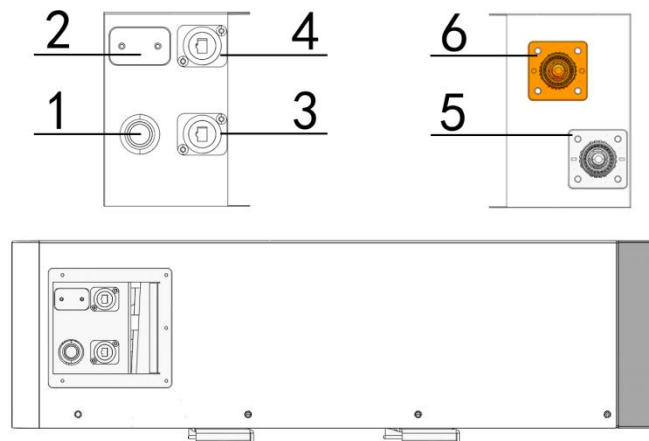

NSTLV-10.2/14.3/16K

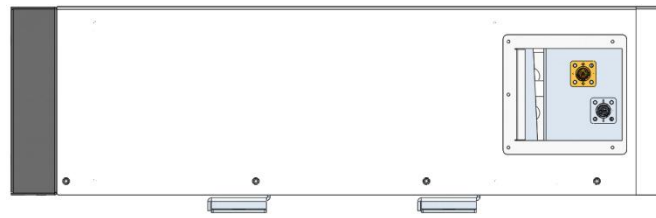

NO.	Items	NO.	Items
1	Power Switch	2	ADDR Dial address
3	COM1(RS485/CAN)	4	COM2(RS485/RS232)
5	Battery negative pole	6	Battery positive pole

4.2.1 Start Button

Press the start button, release the button, and the button is locked.

4.2.2 Dip Switch Definition

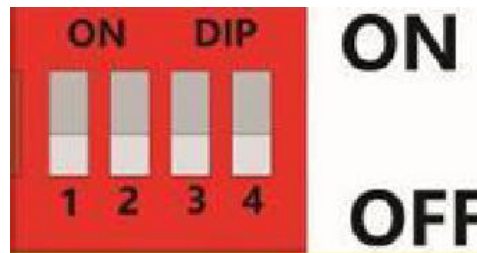

Schematic Diagram of the Dial-up Switch

The dial-dip switch is used to set the BMS address of each battery. The code value of the dial-ON position is 1, and the code value of the dial-1234 position is 0.

The host battery address is 1, and the slave battery address is 2 to 15. (The host is connected to the inverter, and the slave machines are arranged in numerical order according to the address)

The dial-up address table is as follows:

Dial-up code location					Add	Dial-up code location					Add	Dial-up code location					Add	Dial-up code location					Add							
#1	#2	#3	#4		#1	#2	#3	#4		#1	#2	#3	#4		#1	#2	#3	#4		#1	#2	#3	#4							
0	0	0	0	X	0	0	1	0	4	0	0	0	1	8	0	0	1	1	12	1	0	0	0	1	9	1	0	1	1	13
1	0	0	0	1	1	0	1	0	5	1	0	0	1	9	0	1	1	1	14	0	1	0	0	1	10	1	1	1	1	15
0	1	0	0	2	0	1	1	0	6	0	1	0	1	10	1	1	0	1	11	1	1	1	1	1	11	1	1	1	1	15
1	1	0	0	3	1	1	1	0	7	1	1	0	1	11	1	1	1	1	1	1	1	1	1	1	11	1	1	1	1	15

4.2.3 COM1 Port

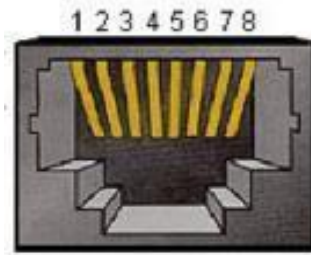

	Definition description		Definition description
PIN1	RS485-B	PIN5	CAN-L
PIN2	RS485-A	PIN6	NC (/)
PIN3	NC (/)	PIN7	RS485-A
PIN4	CAN-H	PIN8	RS485-B

The CAN communication terminal (RJ45 port) follows the CAN/RS485 protocol and connects to the inverter BMS for communication. The BMS controls the charging current/charging voltage or discharge current/discharge cut-off voltage of the inverter based on the battery voltage and battery temperature through CAN/RS485 communication.

4.2.4 COM2 Port

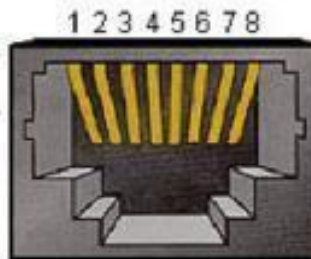

	Definition description		Definition description
PIN1	RS485-B	PIN5	RS232-GND
PIN2	RS485-A	PIN6	NC (/)
PIN3	RS232-TX	PIN7	RS485-A
PIN4	RS232-RX	PIN8	RS485-B

Com2 communication terminal (RJ45 port) follows RS485 / RS232 protocol and communicates internally when multiple batteries are combined or connect the PC.



NSTLV-10.2/14.3/16K

4.3 LED Display Description

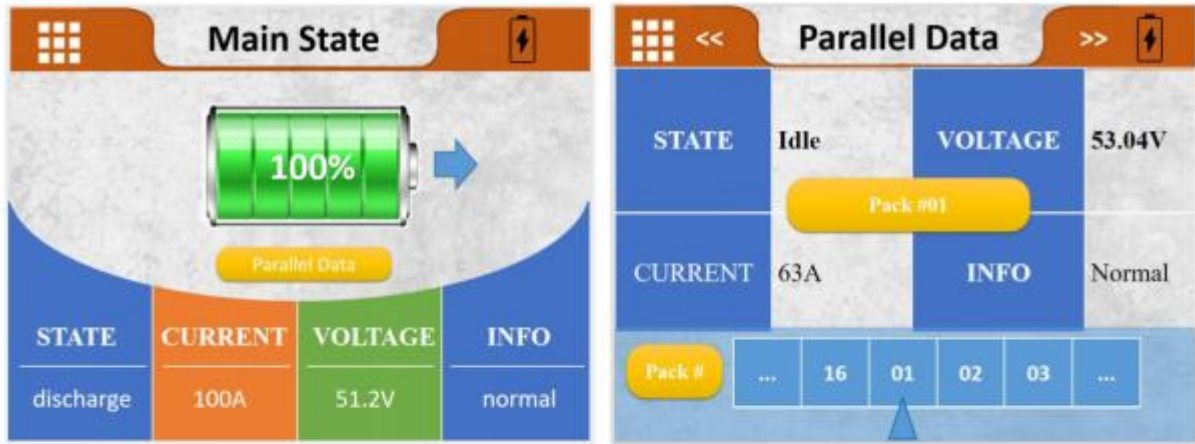
4.3.1 Main Sate Interface



Description:

	Home Page, click to enter the interface
	Main State, click to enter the interface
	Parallel Data, click to enter the interface

4.3.2 Home Interface

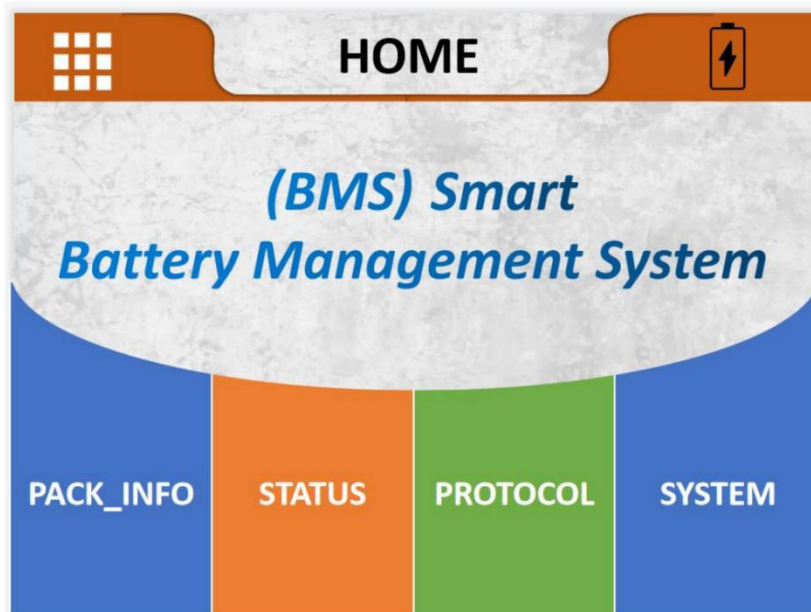

4.3.3 Menu Structure

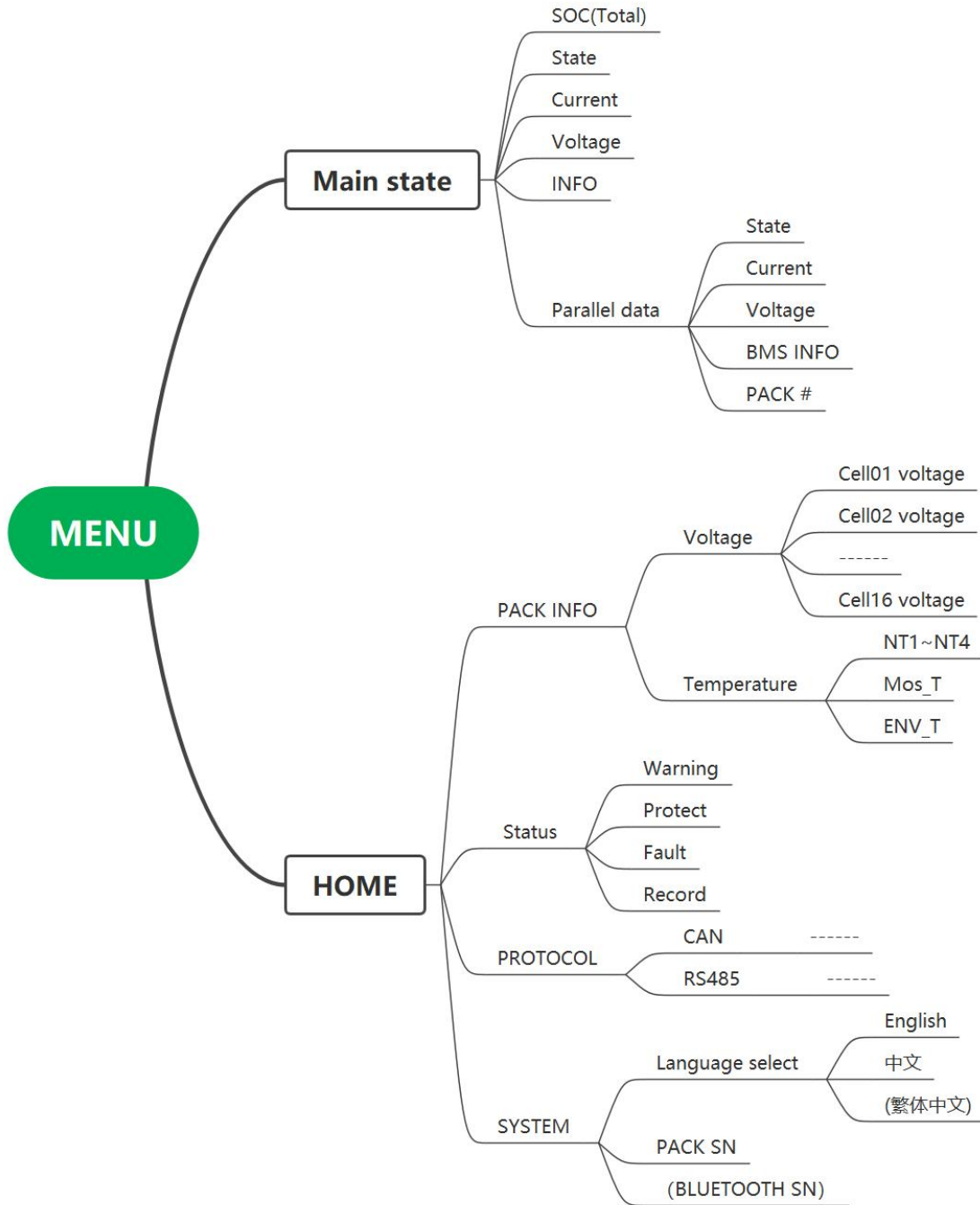

* Changing the protocol requires password, the initial password is 123456, the password effects once.

NSTLV-10.2/14.3/16K

5 Installation guide

5.1 Inspection Before Installation

5.1.1 Check the Outer Packaging

Packaging materials and components may be damaged during transportation. Therefore, please check the packaging material before installing the battery. Check the surface of packaging materials for damage, such as holes and cracks. If any damage is found, do not unpack the battery and contact the dealer as soon as possible. It is recommended that you remove the packaging material within 24 hours before installing the battery.

5.1.2 Check Whether the Accessories Are Complete

After opening the packing box, check whether the attached accessories are complete. If any damage or missing parts are found, contact your dealer.

Accessories list in the package

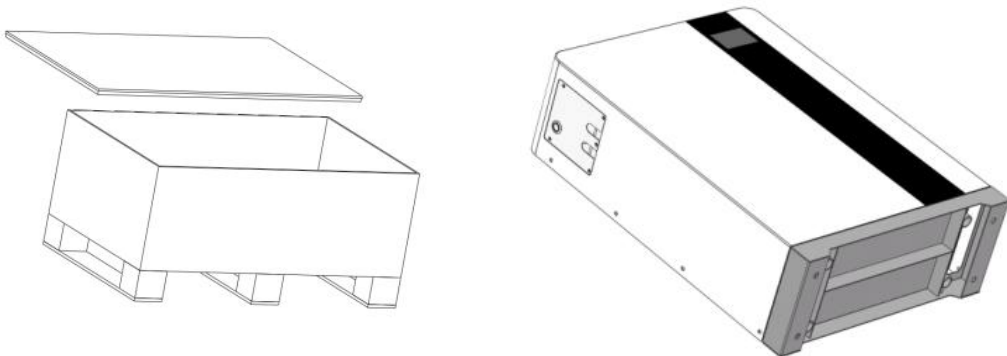

NSTLV-10.2/14.3/16K

NSTLV-10.2/14.3/16K					
NO.	Name	Model	Unit	Qty	Mark
1.	Battery	NSTLV-10.2K	PCS	1	Based on order model
1.	Battery	NSTLV-14.3K	PCS	1	
1.	Battery	NSTLV-16K	PCS	1	
2.	Base	NSTLV-10.2K-01-08	PCS	1	10.2K only
3.	Wall hanging	Steel	SET	1	10.2K only
4.	Positioning paper case		PCS	1	10.2K only
5.	Cross outer hexagon bolt	M8*25	PCS	2	For base bottom fix
6.	Internal expansion screw	M10*80 (304)	PCS	4	For wall/ base installation
7.	Hexagon socket screw	M12*55 (tooth length 36mm)	PCS	4	For base fix
8.	RS232-USB cable		SET	1	For information reading
9.	Connector	200A, orange +, black -	SET	1	
10.	Extra soft silicone wire	2AWG, black, 1.5M	PCS	1	For inverter connection
		2AWG, red, 1.5M	PCS	1	
11.	Network adapter	1 to 2	PCS	1	For battery parallel
12.	OT terminal	25-10	PCS	2	Back-up
13.	Heat shrinkable tube	Ø12 (40 mm)	PCS	2	Back-up
14.	Communication cable	1+1 crystal head/ 1.5m	PCS	1	For inverter communication
		Network cable 1m	PCS	1	Back-up
		1+1 crystal head/ 0.2m	PCS	1	For battery parallel
15.	Crystal head	8P/ gilding 3U	PCS	2	Back-up
16.	Universal wheel		PCS	4	Optional
17.	Built-in WIFI module		PCS	1	Optional
18.	User manual	NSTLV-10.2/14.3/16K manual	PCS	1	

NSTLV-10.2/14.3/16K

Manufacturing instructions for power cable terminals:

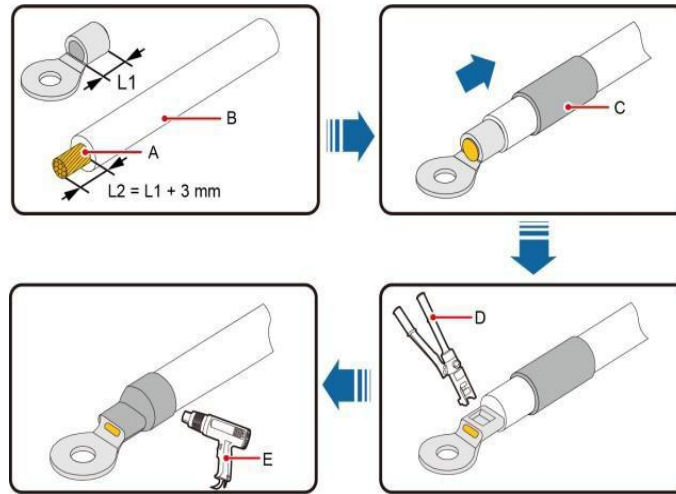



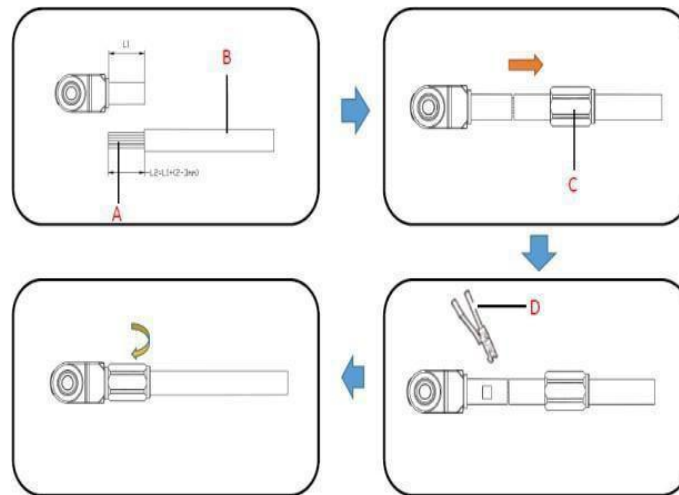



(A) Copper Core Line (B) Insulation layer
(C) Heat-shrink tube (D) Hydraulic pliers
(E) Hot-air gun



(A) Copper Core Line (B) Insulation layer
(C) Protective cover (D) Hydraulic pliers

NSTLV-10.2/14.3/16K

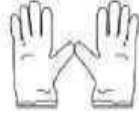
5.2 Tools

Type	Tools			
Installation tools	Measuring tape 	Hammer drill 	Socket wrench 	Cross screwdriver 
Protective equipments	ESD gloves 	Safety goggles 	Anti-dust respirator	Safety shoes 

5.3 Installation Requirements

Installation Environment Requirements:

1. Install the battery in an indoor environment.
2. Place the battery in a safe position away from children and animals.
3. Do not place the battery near any heat source, and avoid generating sparks.
4. Do not expose the battery to moist air or liquid.
5. Do not expose the battery to direct sunlight.
6. Do not expose the battery to a combustible gas or liquid.
7. The mounting carrier shall be fire resistant. Do not install batteries on flammable buildings.

5.4 Installation Instructions

5.4.1 Overall Dimensions

NSTLV-10.2/14.3/16K

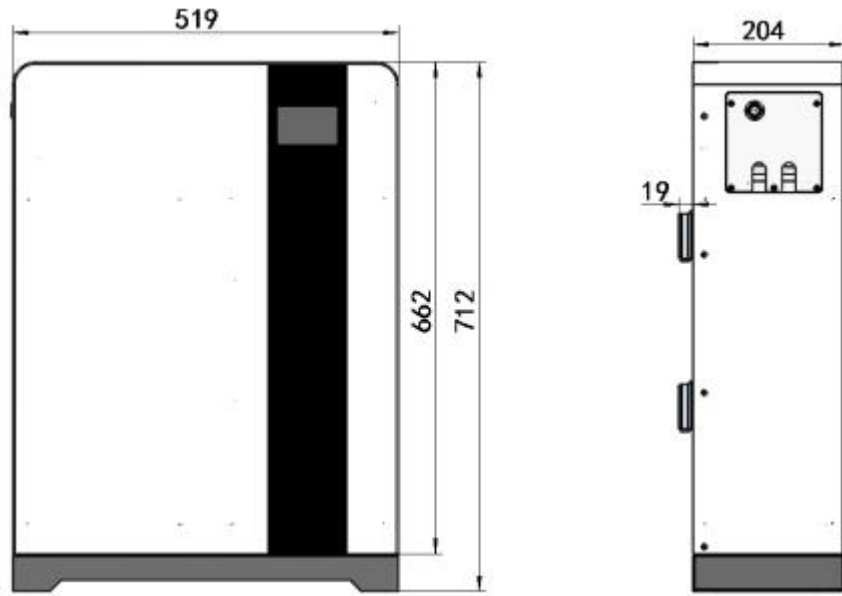

NSTLV-10.2K



NSTLV-14.3/16K

NSTLV-10.2/14.3/16K

5.4.2 Minimum Installation Distance

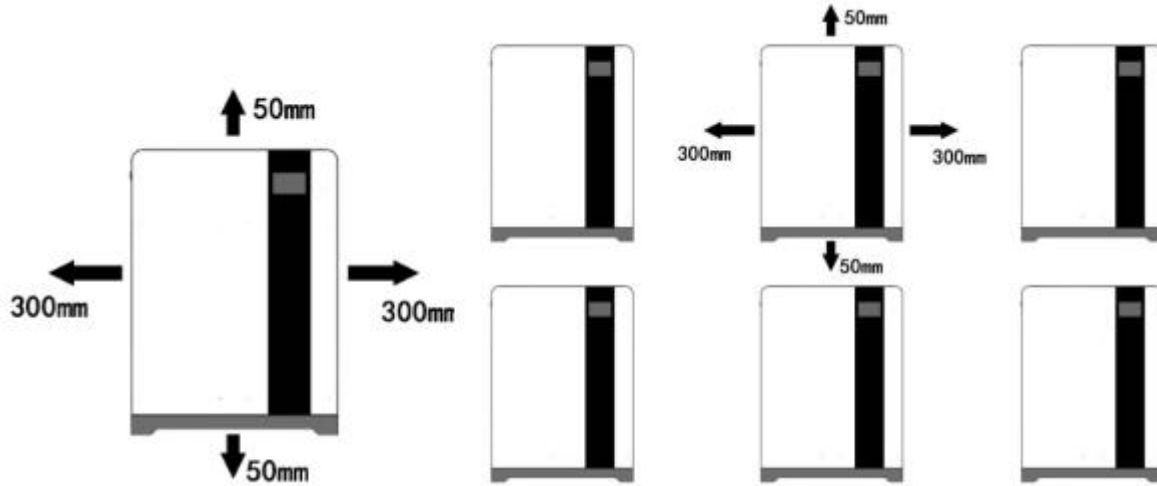

5.4.3 Fix the Battery

① Wall installation (*NSTLV-10.2K only*)

Fix the accessory “positioning paper case” to the wall, drill holes; punch in the expansion screw, lock the hanging plate and hang the battery in.

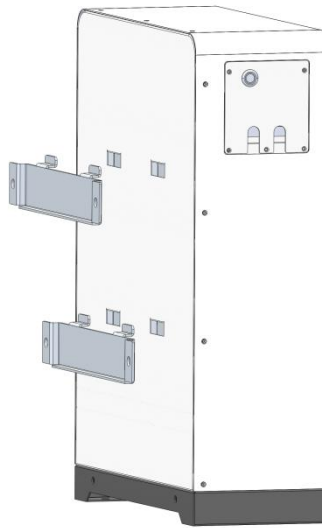

② Ground installation

Drill the expansion screw on the ground according to the base; battery lock the base and the fixing screw, fix the battery with expansion screw. (If there is an optional universal wheel, screw the wheel directly into the hole without installing the base)

NSTLV-10.2/14.3/16K

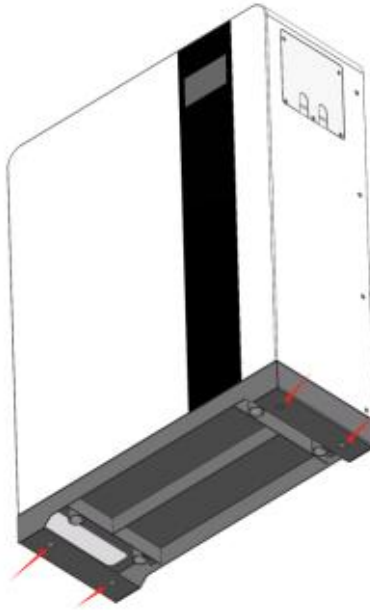

5.4.4 Connect the Power Cable

If need parallel, ensure that the voltage difference between parallel batteries is within 1V; for system efficiency, it is recommended the the battery production date within 1 year.

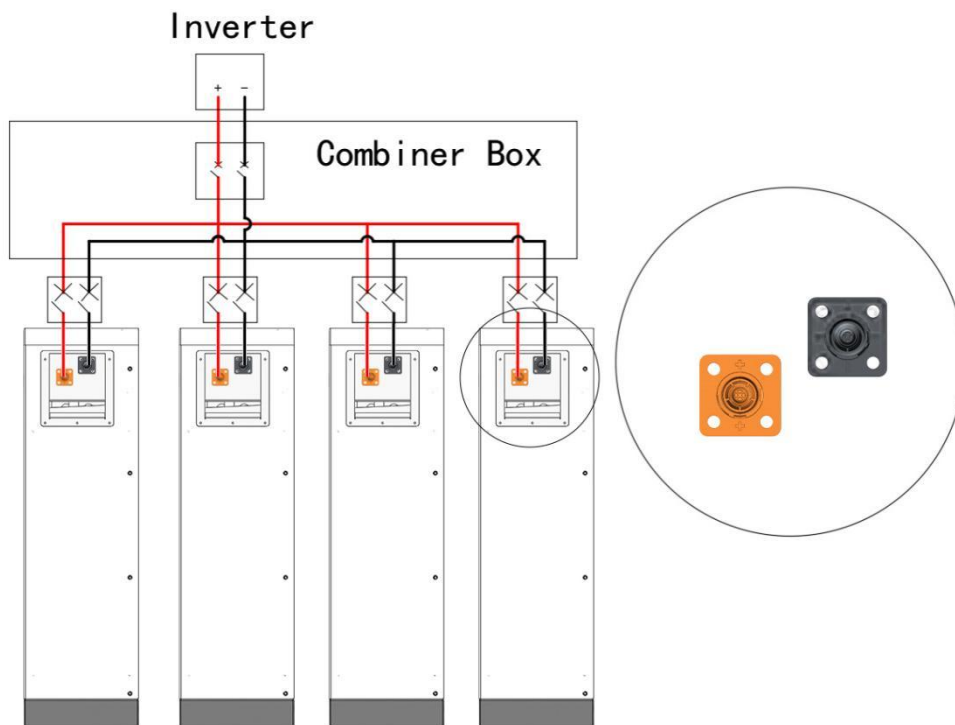

NSTLV-10.2/14.3/16K

5.4.5 Connect the Internal Communication Line

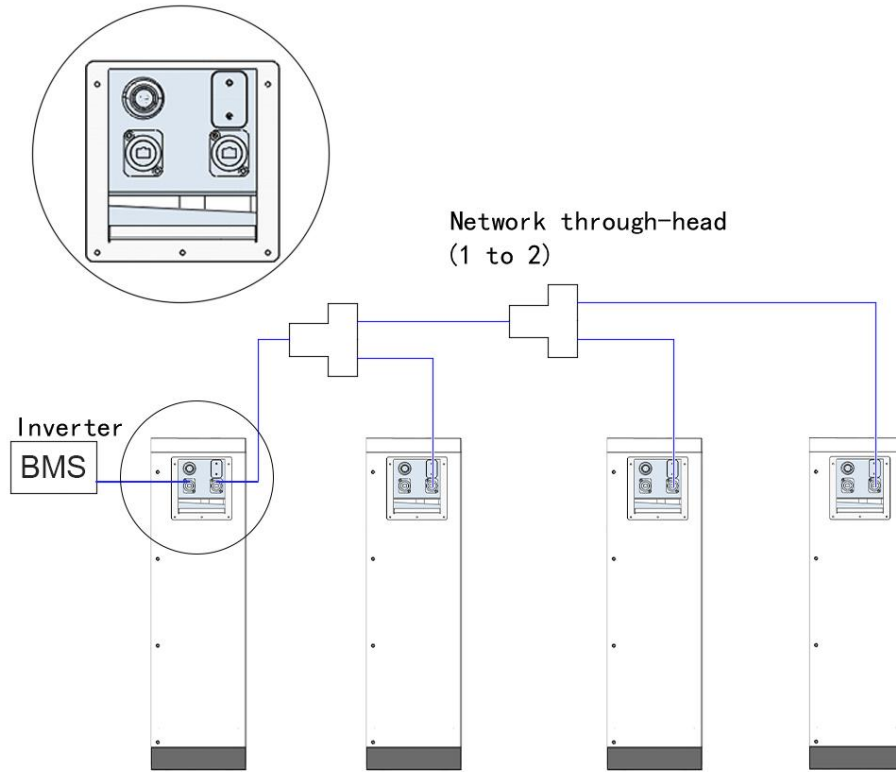

5.4.6 Set BMS Communication Address

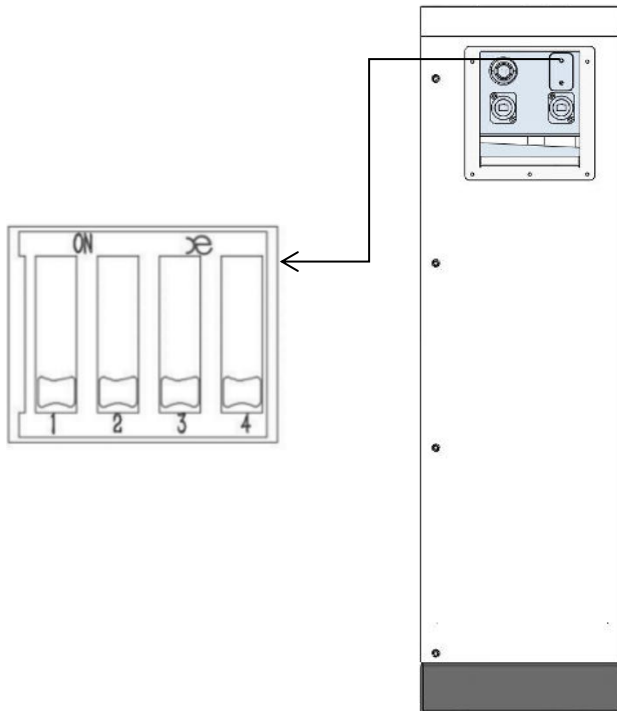

Please refer to 5.2.3: the dialing rule is to set the battery module address in sequence.

NSTLV-10.2/14.3/16K

5.4.7 Connect the Built-in Wifi Module (Optional)

After downloading the monitoring software, you can choose between Bluetooth connection and wifi binding. After binding to wifi, you can remotely monitor, modify parameters, and upgrade programs.

If there is an optional wifi module, please refer to the attached wifi manual for specific connection settings.

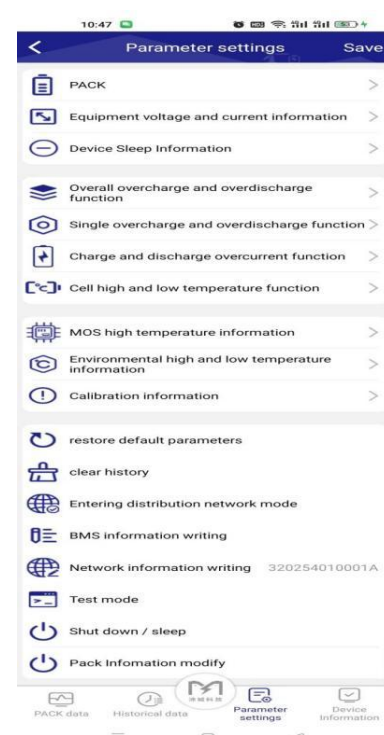
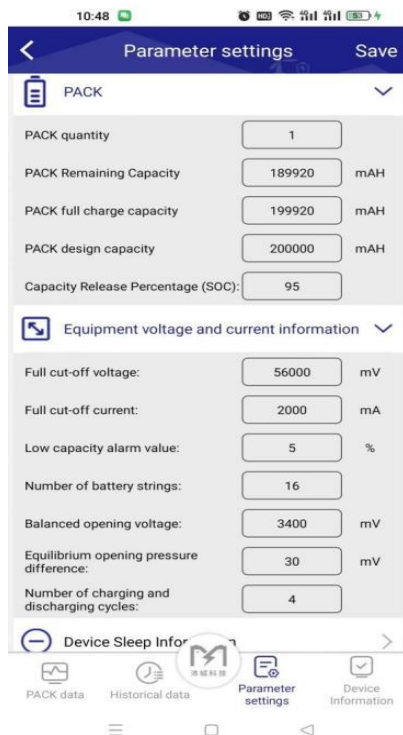

NSTLV-10.2/14.3/16K

6 Cleaning and Maintenance

6.1 Cleaning Work

Please note: please turn off the power supply of the system before cleaning. It is recommended to clean battery regularly. If the shell is dirty, please use a soft and dry brush or dust collector to remove the dust. Do not use solvents, or corrosive liquids to clean the enclosure.

6.2 Maintenance

6.2.1 Recharging Requirements During Normal Storage

The battery shall be stored in an environment with a temperature range of $-10^{\circ}\text{C}\sim 45^{\circ}\text{C}$ and shall be maintained regularly according to the following table to 0.5C current is charged until 40%SOC after long storage.

Charging conditions during storage

Store the ambient temperature	Relative humidity of the storage environment	Storage time	SOC
Below -10°C		Prohibit	/
$-10\sim 25^{\circ}\text{C}$	5%~70%	≤ 12 months	$30\%\leq\text{soc}\leq 60$
$25\sim 35^{\circ}\text{C}$	5%~70%	≤ 6 months	$30\%\leq\text{soc}\leq 60$
$35\sim 45^{\circ}\text{C}$	5%~70%	≤ 3 months	$30\%\leq\text{soc}\leq 60$
Above 45°C		Prohibit	

6.2.2 Recharging Requirements for Excessive Discharge

Charge the over-discharge (90%DOD) battery within the time of meeting the table below, otherwise the over-discharge battery module will be damaged.

Charging requirements for excessive battery discharge

Steerage environment temperature	Storage time	Note:
$-10\sim 25^{\circ}\text{C}$	\leq on Day 15	The battery pack disconnected to PCS, charge the battery with DC charger.
$25\sim 45^{\circ}\text{C}$	\leq on Day 7	
$-10\sim 45^{\circ}\text{C}$	<for 12 hours	Battery pack connect to the Inverter, charge the battery with PV or grid.

7 Common Issues and Solutions

7.1 Common Issues and Solutions

The user can monitor the operating status, warning, and alarm information through the inverter LCD display.

1. The battery cannot be turned on, and the LED indicator lights all turn off the battery depth discharge and requires charging first. If the external charger supply voltage is 51V or above and the battery still cannot be opened, contact the authorized dealer.

2. If red light shows system abnormal, please check below values:

1) Temperature: Above 60°C or below 0°C, the battery protection turns on, could not charge.

Solution: Move the battery to normal operating temperature range between 0°C to 60 °C.

2) Temperature: above 60°C or below -20°C, the battery cannot discharge.

Solution: Move the battery to normal operating temperature range between -20°C to 60 °C.

3) Current: If current is greater than 200A, (*NSTLV-10.2K with limited current 200A*) the battery protection device will be turned on.

Solution: Stop using electrical appliances that exceed the maximum battery power load.

4) High voltage: If the battery voltage is above 57.9V or above, battery charging protection turns on.

Solution: The inverter will stop charging the battery if it sets the intelligent LI mode or a reasonable charging voltage.

5) Low voltage: The battery discharge protection is turned on when the battery discharges to 46.4V or lower.

Solution: Charge the battery until the red light goes off.

Excluding the above five points, if the fault cannot be found, turn off the battery and contact the authorized dealer.

3. It's normal that the SOC LED are different if in multiple battery parallel systems. Before installing batteries in parallel, measure the voltage of each battery to ensure that the voltage difference of each battery is within 1V, and the the battery production date within 1 year.

1) When installing for the first time, please charge in full first to balance the capacity gap;

2) If the error is within 10% when the lowest SOC display percentage is compared with the highest SOC display percentage, and the SOC display percentage is the same within 10

NSTLV-10.2/14.3/16K

minutes, it is normal operation;

- 3) Before expanding battery capacity, please charge and discharge the online battery to 45%-50%SOC; After expanding the capacity, charge the battery system to balance the capacity gap. Ensure that the capacity difference before parallel is no more than 10%. If the capacity gap is large, it will take about 2 cycles to balance the capacity gap. The actual equilibrium time depends on the capacity difference and the charge-discharge current.

Exclude the above three points. If the SOC display still fails, please contact the authorized dealer.

7.2 Emergency

Please cut off the power supply and turn off the battery in an emergency.

1. **If the battery pack is damp or immersed in water**, do not get close to the battery, and then contact the authorized dealer for technical support.
2. **Do not use water to fire when a fire!** Only dry powder extinguishers; place the battery pack in a safe area if possible.
3. **Battery leaking the electrolyte** **If the battery pack leaks the electrolyte**, avoid contact with leaking liquid or gas.

If someone is exposed to the leaking material, do the following immediately:

Inhalation: evacuate the contaminated areas and seek medical treatment.

Contact eye: Rinse eyes with running water for 15 minutes and seek medical treatment.

Contact skin: Wash the infected site with soap and water and seek medical treatment.

Swallow in: urge vomiting, and seek medical treatment.

Battery damage: Damaged battery is dangerous and must be treated with very carefully. Battery cannot be used or may be dangerous to person or property. If the battery pack is damaged, contact the authorized dealer for handling.

7.3 About Battery System

1. The system treatment must comply with the locally applicable disposal regulations of electronic waste and second-hand batteries.
2. Do not treat the battery system along with household waste.
3. Avoid exposing the battery to high heat or direct sunlight.
4. Avoid exposing the battery to high humidity or corrosive environments.
5. Do not expose the battery to a combustible gas or liquid.